

PLAN

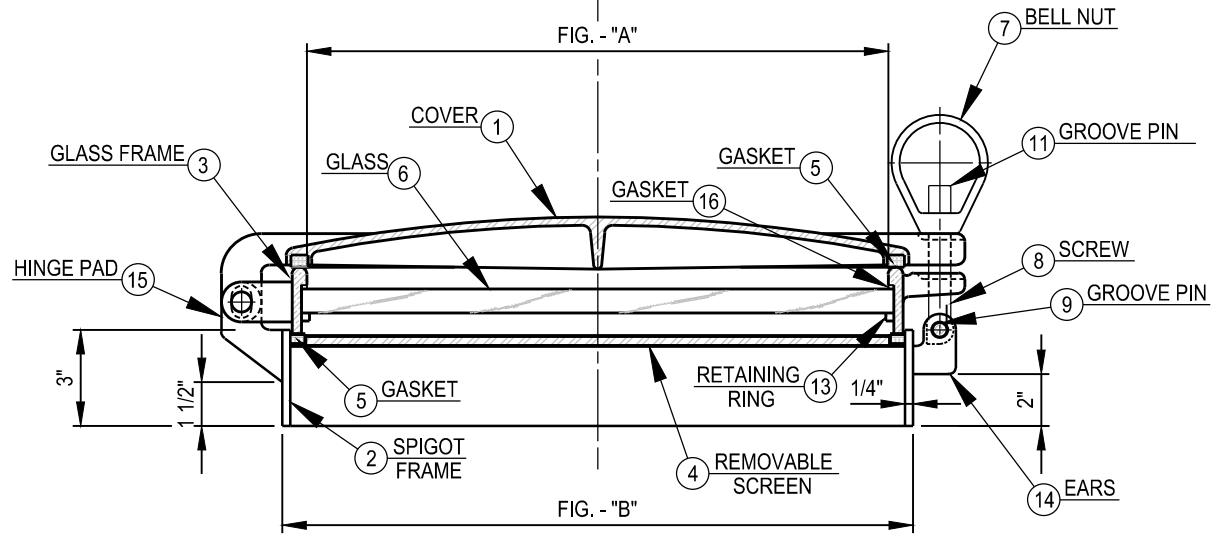

SECTION

SCHEDULE OF MATERIALS		
PC.	MATERIAL	REMARKS
1	ALUMINUM	
2	ALUMINUM	
3	ALUMINUM	
4	STAINLESS	
5	NEOPRENE	
6	GLASS	
7	ALUMINUM	
8	ALUMINUM	
9	STAINLESS	
10	STAINLESS	
11	STAINLESS	
12	STAINLESS	
13	ALUMINUM	
14	ALUMINUM	
15	ALUMINUM	
16	NEOPRENE	

DIMENSION SCHEDULE							
SIZE:	8	10	12	14	16	18	
DIMS:	A	8	10	12	14	16	18
	B	9-5/8	11-5/8	13-5/8	15-5/8	17-5/8	19-5/8

**CEN-TEX MARINE FABRICATORS, INC.**  
 SMITHVILLE, TEXAS  
 ALUMINUM PORTLIGHT - WELD IN  
 DWG. NO.: 700-A